

---

# EdgeX Planning Conference Odessa Release Virtual Meeting

---

Dec 4<sup>th</sup> – 6<sup>th</sup> 2023



# Conference Agenda

- Dec 4, Monday, 7am - Kick Off and Main Architecture Discussions
  - Introductions and Meeting Logistics
  - Conclude any Napa Issues
  - Odessa Aims and Objectives
  - Odessa Architecture Discussions
- Dec 5, Tuesday, 9am - Architecture Discussions and Odessa Scoping
  - “R” release naming
  - Odessa Architecture Discussions Cont.
  - Odessa Scoping by Working Group
- Dec 6, Wednesday, 7am - Complete Odessa Scoping, Business and Marketing Topics, Lessons Learnt
  - Odessa Scoping by Working Group Cont.
  - Business and Marketing Topics
  - Project Process Improvements
  - Lessons Learnt, Continuous Evaluation, etc,

All times in  
PST





---

# Intros

Name, rank, serial number please

---



---

# Day 1

---

# Conference Agenda – Day 1

All times in  
PST

- 7:00am - Introductions
- 7:15am - Napa release (any unfinished business, issues, etc)
- 7:30am - Odessa Aims and Objectives release – high level agreement
- 8:00am - Odessa Architecture Discussions
- 10:00am - Day 1 adjourn

If we have extra  
time today, we  
may bring more  
topics forward



# TSC Membership Update

10 EdgeX Technical Steering Committee Members  
 Corey Mutter now approved to replace Tom Brennan



## Working Group Chairs:

- Cloud Tsai (IOTech) Core & Test/QA WG Chair
- Lenny Goodell (Intel) Applications & Analytics WG Chair
- Lindsey Cheng (IOTech) Device Services WG Chair
- Ernesto Ojeda (Intel) Dev Ops WG Chair

## At Large Members:

- Farshid Tavakolizadeh (Canonical)
- Tom Brennan (Eaton)
- Elizabeth Lee (Intel)
- Melvin Sun (Intel)
- James Butcher (IOTech)
- Darryl Mocek (Oracle)

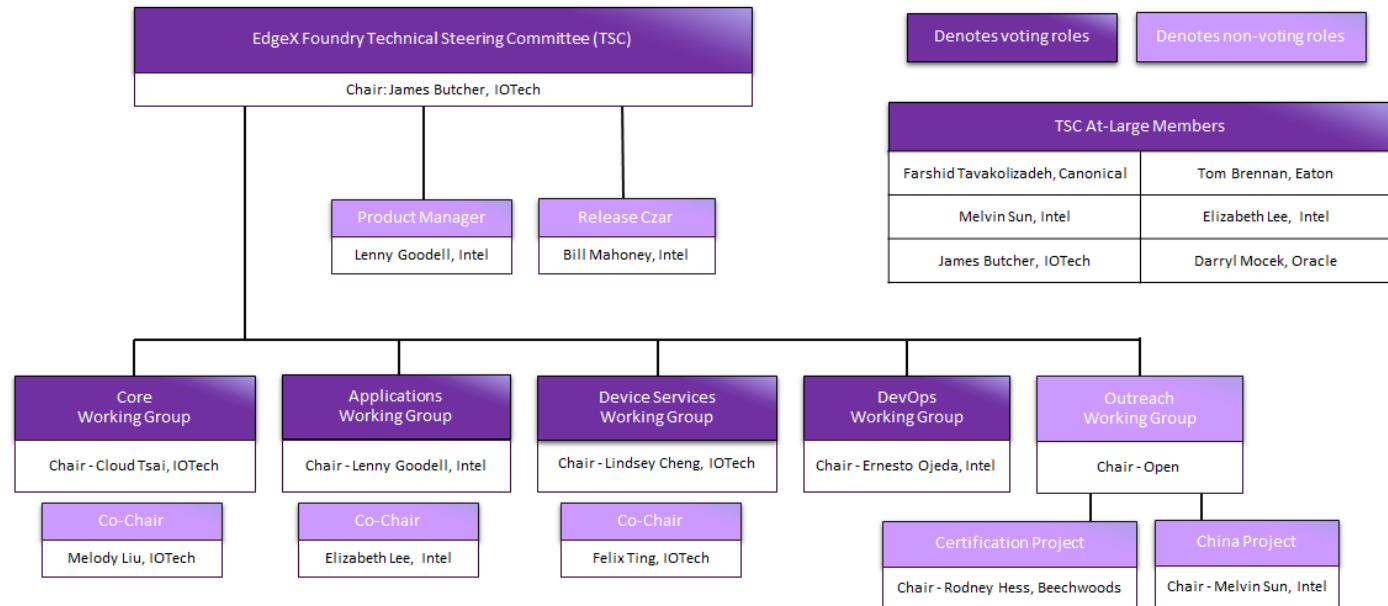



# Remaining Napa Items

- Still be done?
  - Release of all Device Services? Which are still TODO?
    - CAN Device Service would be a 3.1.0
    - S7 Device Service still in holding – release TBD
  - Any remaining doc updates? See Odessa docs now marked as WIP
  - Performance metrics report (in progress)
- Collateral / Marketing:
  - <https://www.edgexfoundry.org/software/releases/>
  - [LF Edge - Napa Release Blog](#)
- Issues/Concerns
  - Docker image footprint has risen around 8-10MB due to ‘apk upgrade’ command to support fixing current and future CVEs. Initial discussions about how to accomplish this without the footprint rise, such as image squashing. To be covered later in these meetings
- Reminder we are now supporting EdgeX 3.1 (Napa) LTS until Nov 2025

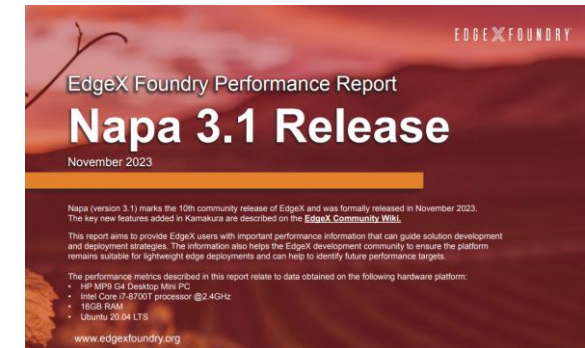



---

# Starting Odessa

---



# Odessa Release



# Odessa Release Objectives/Size – As discussed in Prewire

- Minor Version - move to 3.2?
  - Expectation so far to not be an LTS (remains at 3.1)
  - LTS Policy: <https://wiki.edgexfoundry.org/pages/viewpage.action?pageId=69173332>
    - Per LTS Policy, Napa will be supported period of 2 years (**to November 2025**) unless otherwise stipulated by the TSC
- Current major additions under consideration – all changes must consider V3 compatibility
  - URI for Files (completion work)
  - Common Configuration (completion work)
  - Hashicorp replacement services
  - Data Modelling and Relationships
  - Microservice authentication based on end-to-end encryption
  - Continue EdgeX docs redesign



# EdgeX Cadence Check

- April/May & Oct/Nov to remain target release months?
  - Napa release (Ernesto) - Nov 2023 
  - Odessa release (Mengyi & Farshid) - April 2024
  - Palau release (Rodney) - Nov 2024
  - Queensland release (Bill) - April 2025
- Next Planning Meeting (likely May 2024)
  - With travel restrictions lifted – is a F2F possible?
  - Volunteers or suggestions on where to hold this meeting?
  - Consider a target conference or event?



'R' release name  
to be announced  
on Tuesday...



# Release Timing Details

- EdgeX has a semi-formal release/planning schedule as follows:
- Generally attempt to select release date about 2 months in advance of the release
  - Typically April and October for spring/fall releases
  - Release date preferred to be a Wednesday
  - Adjust per circumstances and TSC review
- Release schedule for minor release
  - Freeze date 2 weeks in advance of release date
  - Prewire, Thursday prior to freeze date
- Release schedule for major or LTS release
  - Freeze date 3 weeks in advance of release date
  - Prewire, Thursday prior to freeze date
- Planning meeting – generally the week following the release
  - Virtual meeting: Monday – Wednesday
  - In person: Tuesday-Thursday
- If travel is necessary – planning meeting may need to be a week out
- Include manual testing in the release schedule



# Formalized Release Timing/Planning

## Example Calendar for Major/LTS Release



## Example Calendar for Minor Release

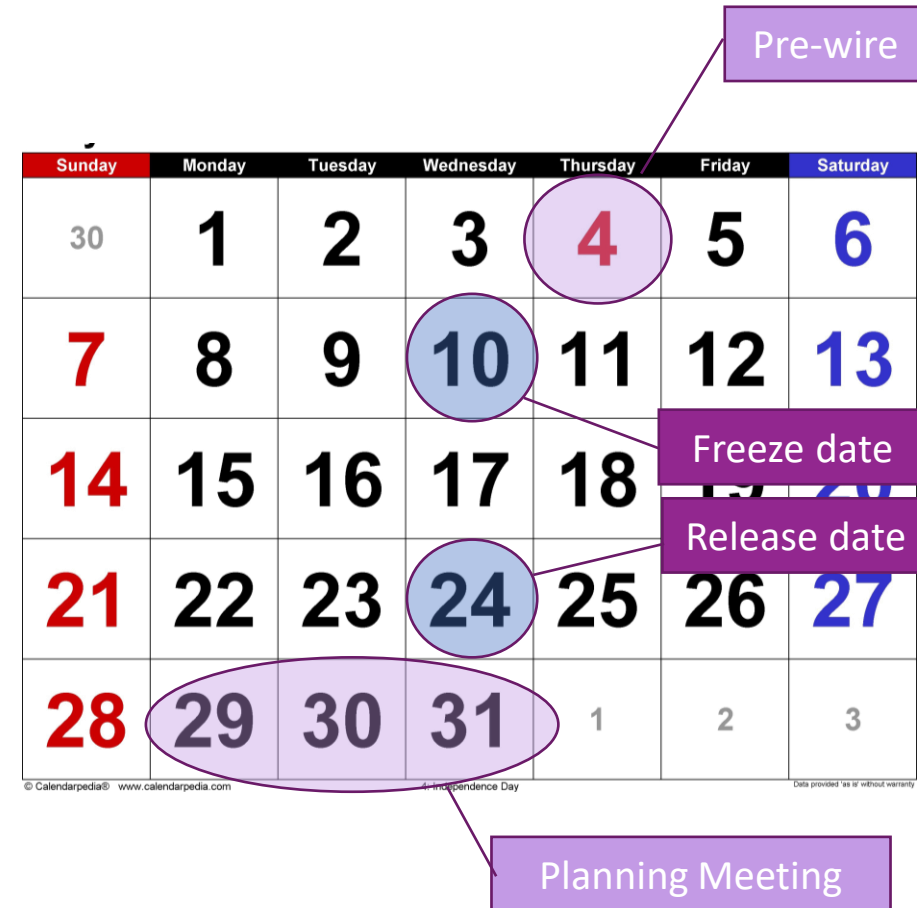



---

# Scoping and Planning

---

# EdgeX Survey Results

- During October the TSC agreed to publish an open survey to obtain community feedback on the most used aspects of the platform
- Aim to use these results to help inform decisions in our planning
- Thanks to Jim White for creating and pushing out the survey

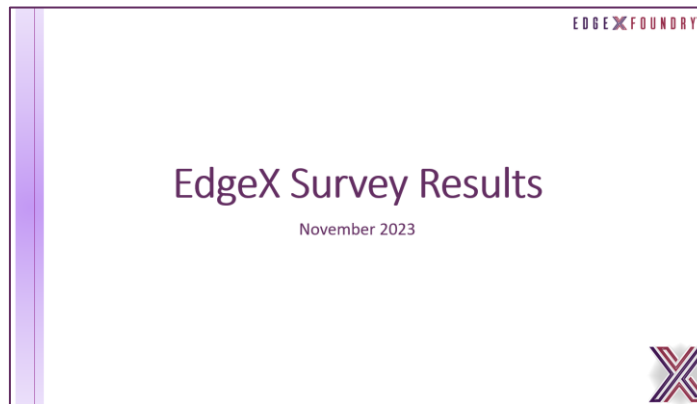



# Scoping Exercise

- Categories used in our Pre-Wire
  - **In scope**
    - It is “In scope” – must be done; no debate; near unanimous consent
    - Should not take (much) time in the planning meeting to discuss
  - **Under consideration**
    - It is definitely under consideration for the planning meeting and release
    - It is not in scope yet, but it worthy of some time to discuss; with a strong tendency to put it in scope
    - Has a majority of support to at least consider it; must be put in or out of scope at the end of the meeting
  - **Not sure/On the fence**
    - There are some that believe it should be under consideration or in scope but others are unsure or even against it.
    - To be reviewed and debated during the planning meeting as time permits; placed out of scope by default if not covered in the planning meeting
  - **Out of scope (Not discussing in this meeting)**
    - A majority believe this work will not be covered in the next release
    - A potentially valid need, but just not going to be accomplished for the next release (example: non-backward compatible change)
    - These items will not be discussed during the planning meeting but will be added to the backlog/roadmap
  - **Never in scope**
    - A majority believe this work will not be (ever) accomplished in EdgeX
    - Remove from the backlog or future scope (with rationale)
    - These items will not be discussed in planning meetings going forward



# Architect's Topic / Prewire List

- In Scope
  - URI for Files (completion work)
  - Common Configuration (completion work)
  - Hashicorp replacement services
  - Data Modelling and Relationships
  - Microservice authentication based on end-to-end encryption
  - Continue EdgeX docs redesign
- Under consideration
- On the Fence
  - Notification Service Improvements
  - NanoMQ
  - EdgeX Lite



# Items already set as “out of scope” or “never in scope”

**Out of Scope** - potentially valid, kept in backlog

**Never in Scope** - will not be accomplished, removed from discussion



# Planning Considerations

- Is there a champion / developer to drive the solution & get the work done
  - Who
  - Timeline
  - Dependencies
- What is high priority and what is a stretch goal?
  - T-shirt size it
    - Small – one release; one WG; one service; approximately one man to complete
    - Med – one release; many services;
    - Large – one release; all services; could take someone all release to finish
    - X-Large – multi-release and probably more than one service





---

# In Scope

---

# URIs for Files (completing V3 work)

- Better configuration capability
  - Potential to use a URI to specify an external configuration location (allowing for file, HTTP, HTTPS or other protocol access support)
  - URI mechanism may be used to point to device profiles, configuration files, UoM and other "configuration" information - i.e., this is not just about the "common" configuration files
- Already completed except for C Services
  - Q: this is the only remaining work here? Yes
  - In Scope. T-Shirt: small. Following similar patterns to the implementation in the Go Device SDK
- Previous Progress
  - UCR Approved - <https://docs.edgexfoundry.org/3.0/design/ucr/URIs-for-Files/>
  - ADR Approved - <https://docs.edgexfoundry.org/3.0/design/adr/0027-URIs%20for%20Files/>
  - EdgeX 3.1 Docs - <https://docs.edgexfoundry.org/3.1/microservices/general/#uri-for-files>



# Common Configuration (completing V3 work)

- Biggest item completed in 3.0, but any more aspects to complete/improve?
  - UCR: <https://docs.edgexfoundry.org/3.0/design/ucr/Common%20Configuration/>
  - ADR: <https://docs.edgexfoundry.org/3.0/design/adr/0026-Common%20Configuration/>
  - EdgeX 3.1 Docs: <https://docs.edgexfoundry.org/3.1/microservices/configuration/CommonConfiguration/>
- 1. One known bug to fix <https://github.com/edgexfoundry/go-mod-bootstrap/issues/534>

Previously said: Out of scope for 3.1. Stretch: Analyze/design a better code solution for writable. Review again in 3.2 planning.

  - Bug description: corner case bug dealing with maps in the writable section. If you try to remove an entry it does not get removed in the resulting service's configuration during run-time. But if you subsequently restart the service it does work. But addressing this bug requires quite a bit of refactoring of the interfacing to Consul to access and handle the writable for the configuration provider
  - Note that bringing in Core-Keeper to 3.2 (TBC in this planning) might also avoid the issue, are we better to focus on Core-Keeper first before addressing this bug? **General consensus is yes, we do Core-Keeper first**
  - **T-Shirt: Large because of the scope of impact. But priority needs to be considered based on value of fix (corner case bug) and the likely replacement of Consul with Core-Keeper which seems to be higher priority**
- 2. Implement Common Config for C Devices (done - this was completed in 3.1)



# Hashicorp Product Replacements – Situation Reminder

- In August 2023, HashiCorp announced they are moving to a Business Source License (BSL)
  - Vs Mozilla Public License (MPL)
  - MPL is compatible with Apache 2
  - <https://www.hashicorp.com/blog/hashicorp-adopts-business-source-license>
- Applies to future releases
  - “The license change is not retroactive. This means all source code and releases prior to the change remain under the MPL 2.0 license.”
  - Vault 1.14.5, Consul 1.16.3 are the last versions under MPL
  - EdgeX uses Vault 1.14 and Consul 1.16
- Regarding Patches to current releases
  - “HashiCorp will continue to backport critical security patches, as available, to existing versions under the MPL 2.0 license until December 31, 2023. Any patches after that date will be provided under the new license.”





# Hashicorp Product Replacements – Meaning of the change to BSL

- The intent of BSL is to protect HashiCorp commercial interests
  - “Organizations providing competitive offerings to HashiCorp will no longer be permitted to use the community edition products free of charge under our BSL license. “
  - “All non-production uses are permitted. All production uses are allowed other than hosting or embedding the software in an offering competitive with HashiCorp commercial products, hosted or self-managed.”
  - Change only impacts production uses
- EdgeX, as an open-source project, is not directly affected – but adopters could be
  - The BSL license does not prohibit or restrict use of HashiCorp products.
  - Our adopters may be impacted – depending on whether they only use EdgeX internally and/or offer a “competitive offering”
    - “A “competitive offering” is a product that is sold to third parties, including through paid support arrangements, that significantly overlaps the capabilities of a HashiCorp commercial product. “
    - Remember, an adopter may offer non-EdgeX products that compete (ex: IOtech has a product that could be considered competitive with Nomad from HashiCorp)



# Hashicorp Product Replacements – Plan for EdgeX

- Recommended for TSC approval
  - Vault -> OpenBao; a forked, open source (See next slide)
  - Consul -> core-edgex-keeper; Eaton/IOTech developed drop-in replacement (See next slide)
- Lift
  - EdgeX participation/liaison with OpenBao
  - Work to update/review/approve core-edgex-keeper (code, docs, tests)
- Plan
  - Have both OpenBao and core-edgex-keeper available by Odessa release
    - Core-Keeper would be brought into edgex-go and go-mod-configuration as an option. Consul 1.16 MPL version remains the default config/registry service due to breaking changes associated with replacing it
      - Core-Keeper uses Redis as its persistence
      - Consider whether a fork of Consul is required as a backup, or if it can be done if/when needed
      - T-shirt: Large
    - OpenBao would be a compose-file change and set as the default. Our docs can describe that Vault can be used if desired
      - Need to check on availability and predicted release date
      - Vault usage remains on the 1.14 MPL version
      - Support for EdgeX 3.1 LTS can include updates to OpenBao if/when needed. Won't break compatibility
      - T-Shirt: Small
  - Backward compatibility? Do we need to still allow for Vault/Consul with EdgeX 3.x releases



# Hashicorp Product Replacements – Consul

- See <https://github.com/edgexfoundry-holding/edgex-core-keeper>
- Project started by Eaton/IOTech Systems to provide a lighter weight alternative to Consul
- API compliant with Consul
  - Not a 100% replacement of all Consul features
  - But a drop-in replacement for EdgeX use of Consul
- Currently in holding for community review
  - Needs to be brought up to EdgeX 3.0/1 standards
  - Documentation needed
  - Testing needed



# Hashicorp Product Replacements – Vault



- OpenBao – open-source Vault replacement
- Name provisional pending LF legal review
- Intention is to be a sub-project under LF Edge (like EdgeX)
- Wiki: <https://wiki.lfedge.org/display/OH/OpenBao+%28Hashicorp+Vault+Fork+effort%29+FAQ>
- They are working on a web site
- Led by IBM
  - Looking for other companies and organizations to support it officially (EdgeX is listed as a supporting org)
- Project currently meeting weekly (Thursday mornings at 9am EST)
  - Zoom: <https://zoom-lfx.platform.linuxfoundation.org/meeting/94640473133?password=34a5aead-aef2-4a39-9e91-c16082afcf5>
  - Calendar URL (to subscribe to the meetings): <https://lists.lfedge.org/g/openbao/ics/12823919/1232060308/feed.ics>
- Hashicorp Vault code has been forked
  - Github: <https://github.com/openbao/openbao/tree/development>
  - IBM engineers and others are working to get it building
  - First task is to rid the code of all Hashicorp references
- Taking feature requests for the future of the project
  - Immediate need is to provide a drop-in replacement for Vault



# EdgeX Data Modelling and Relationships – rolled over from 3.1

- Parent/Child Devices – Last time said scope: **Small**
  - Add optional relationship metadata property that indicates a parent device to build hierarchical relationships between devices (often required at the northbound side for groupings management and presentation)
    - ADR not required, not cross cutting. Eaton to raise a usual issue/PR and document the need here
- Virtual Device Resources – Last time said scope: **Small (medium because affects multiple services)**
  - Means to extend a southbound device's profile with new resources (e.g., min, max, alarms, trends) that are added and managed by a higher-level service (e.g., analytics, utility or exporter)
    - Updated [UCR](#) to describe virtual device resource concept; ADR not required. Eaton to raise an issue/PR as normal
    - **Corey: Perhaps the highest priority item. Next step to raise an issue and attend Device Services WG**
- Provision Watch via Device Metadata Last time said scope: **Small/Med**
  - Allow device provision watchers to utilize both device metadata (e.g., serial number, MAC address, etc) and the existing protocol properties as needed
    - General enhancement on provisioning; ADR not required. Eaton to raise an issue/PR as normal



# EdgeX Data Modelling and Relationships – New UC1

- **Protocol-specific Attribute Values in Device**
- There are many different manufacturers of the same type of device (e.g. HVAC). The Device Profile of a specific type of device could be used for many or all of the Devices of that type, reducing the need to duplicate a Device Profile just to account for differences in the protocol-specific attribute values.
- Example:
  - Two different manufacturers may build an HVAC using Modbus, and another may build an HVAC using SNMP. A single Device Profile cannot be created for 3 HVACs with three since HVAC1 and HVAC2 use the same protocol entry for the attribute - 'HoldingRegister'.
  - Since these three devices are the same type of device, all HVACs with temperature attributes, just having different protocols, the protocol information should reside in the Device, which describes a specific (instance of a) device. In this scenario all three devices can use the same Device Profile. This becomes more important as you have more devices, potentially increasing the number and management of Device Profiles when one will do
- **Requirement Summary**
  - The requirement is to support the protocol-specific attribute values (e.g. HoldingRegister) in the Device as well as the Device Profile (for backward compatibility).
  - If only the Device contains a protocol-specific attribute, it is used for that device.
  - If only the Device Profile contains a protocol-specific attribute, it is used for all Devices that have that Device Profile.
  - If both the Device Profile and the Device contain a protocol-specific attribute, the entry in the Device overrides the one in the Device Profile.
- For Odessa: Discuss, UCR, ADR, Implementation?
  - In scope (UCR at least). Lenny points out that Devices don't currently have DeviceResources as shown in Darryl's example.
  - Darryl is trying to reduce the number of device profiles that may be needed for the same type of device
  - Let's check the needs with a UCR



# EdgeX Data Modelling and Relationships – New UC1

## Device Profiles

```
...
name: HVAC1DP
deviceResources
-
  name: temperature
  attributes:
    { HoldingRegister: "4028" }
    { oid: "1.3.6.1.4.1.20440.4.1.5.1.2.1.3.2" , community: "private" }
...
name: HVAC2DP
deviceResources
-
  name: temperature
  attributes:
    { HoldingRegister: "7055" }
```

## Devices

```
name: HVAC1
deviceResources
-
  name: temperature
  attributes:
...
...
name: HVAC2
deviceResources
-
  name: temperature
  attributes:
```



## Device Profile

```
...
name: HVAC
deviceResources
-
  name: temperature
...
Devices
```

```
...
name: HVAC1
deviceResources
-
  name: temperature
  attributes:
    { HoldingRegister: "4028" }
...
name: HVAC2
deviceResources
-
  name: temperature
  attributes:
    { HoldingRegister: "7055" }
...
name: HVAC3
deviceResources
-
  name: temperature
  attributes:
    { oid: "1.3.6.1.4.1.20440.4.1.5.1.2.1.3.2" , community: "private" }
...
```



# EdgeX Data Modelling and Relationships – New UC2

- **Device Functions**
- Many devices contain functions that can be called, like the ability to reboot a device. EdgeX currently does not support the ability to invoke device functions, making parts of devices inaccessible
- EdgeX supports setting attributes on a device. The workaround for calling device functions currently in EdgeX is to configure a device to call a function when setting an attribute, which isn't always feasible
- Each Device should have a function resource and its parameters defined to support calling the device function with appropriate parameters
- **For Odessa: Discuss, UCR, ADR, Implementation?**
  - **In Scope: UCR at least**
  - **Historic ADR here to review: <https://github.com/edgexfoundry/edgex-docs/pull/644>**





# Microservice authentication based on end-to-end encryption

- Previously referred to as “Zero Trust / Secure Distributed EdgeX (OpenZiti Integration)”
  - See As-is and To-be diagrams on next slides
- UCR [Approved]: <https://docs.edgexfoundry.org/3.1/design/ucr/Microservice-Authentication/>
- ADR [In Review]: <https://github.com/edgexfoundry/edgex-docs/pull/935>
  - Oriented at the minimal implementation of including OpenZiti
- Implementation in this cycle? Clint @ NetFoundry is ready to push PRs
  - See Clint’s demo: <https://www.youtube.com/watch?v=ARuGmzNuz-w>
  - In this prototype, OpenZiti client libraries have been directly linked in to EdgeX's basic microservices and have replaced the standard TCP/IP listeners and dialers that most REST-based microservice architectures rely on. The demo also includes a “Zitifed” a third-party component, the eKuiper rules engine, which was done with only a few lines of code. The Zitifed services have no open HTTP ports that can be attacked, and all inbound REST calls are authenticated by an OpenZiti-linked identity. Only the OpenZiti control plane and edge router components bear the risk of exposed ports.
  - For Odessa - ADR (TSC: to approve) and Implementation. T-Shirt: Medium. Large to include C-SDK



# EdgeX Security - Minnesota (3.0) and Napa (3.1)

- Expanded Vault to include issuing and validating JWTs. Vault and not Kong own JWT issuance and validation
- Kong was actually replaced with the lighter/simpler NGINX. All inbound requests authorized by plugin that delegates JWT checking to Vault. Transparent to the caller (as before)
- Every service requires a JWT to be passed as part of the request that is validated
- Every service uses Vault-supplied JWT to authenticate outgoing calls
- Also every service will be assigned a Vault identity, so possible to configure Vault authentication engines against Vault identifies – e.g. Auth0, Kubernetes services

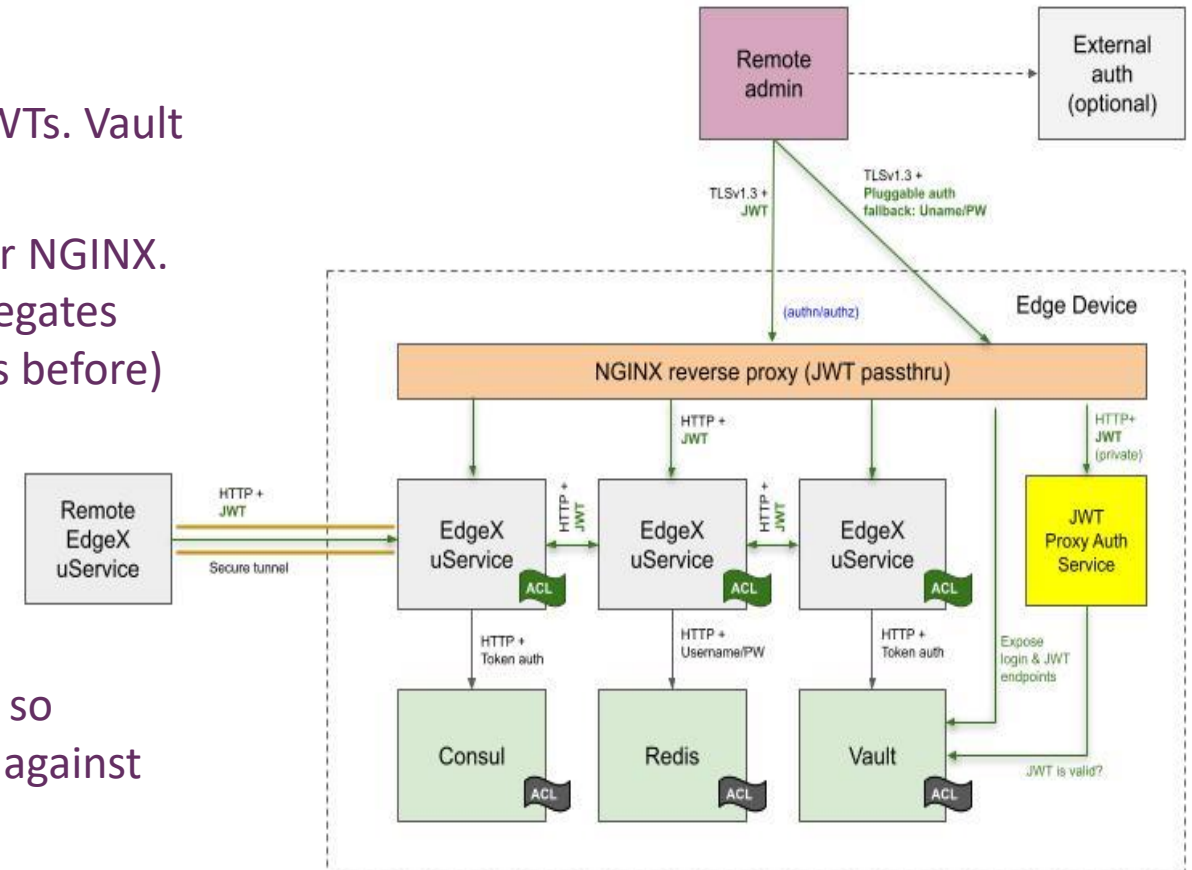

# EdgeX Security - Outlined in ADR

- Under this ADR, EdgeX microservices will directly integrate with the OpenZiti SDK. Integration with the OpenZiti SDK enables EdgeX microservices to natively communicate on the OpenZiti zero-trust network. However, to be fully functional, an adopter must also run an OpenZiti controller, one or more OpenZiti router components, and zero or more OpenZiti tunnelers to support legacy applications. Examples of a legacy applications include curl clients and Postman running in a users' browsers
- In a zero-trust architecture, an API gateway is no longer required for remote access to EdgeX microservice API's. If an API gateway is still desired, it is still possible to run the EdgeX 3.0 API gateway in conjunction with an OpenZiti tunneler to onboard API gateway traffic onto the zero-trust network on the backend

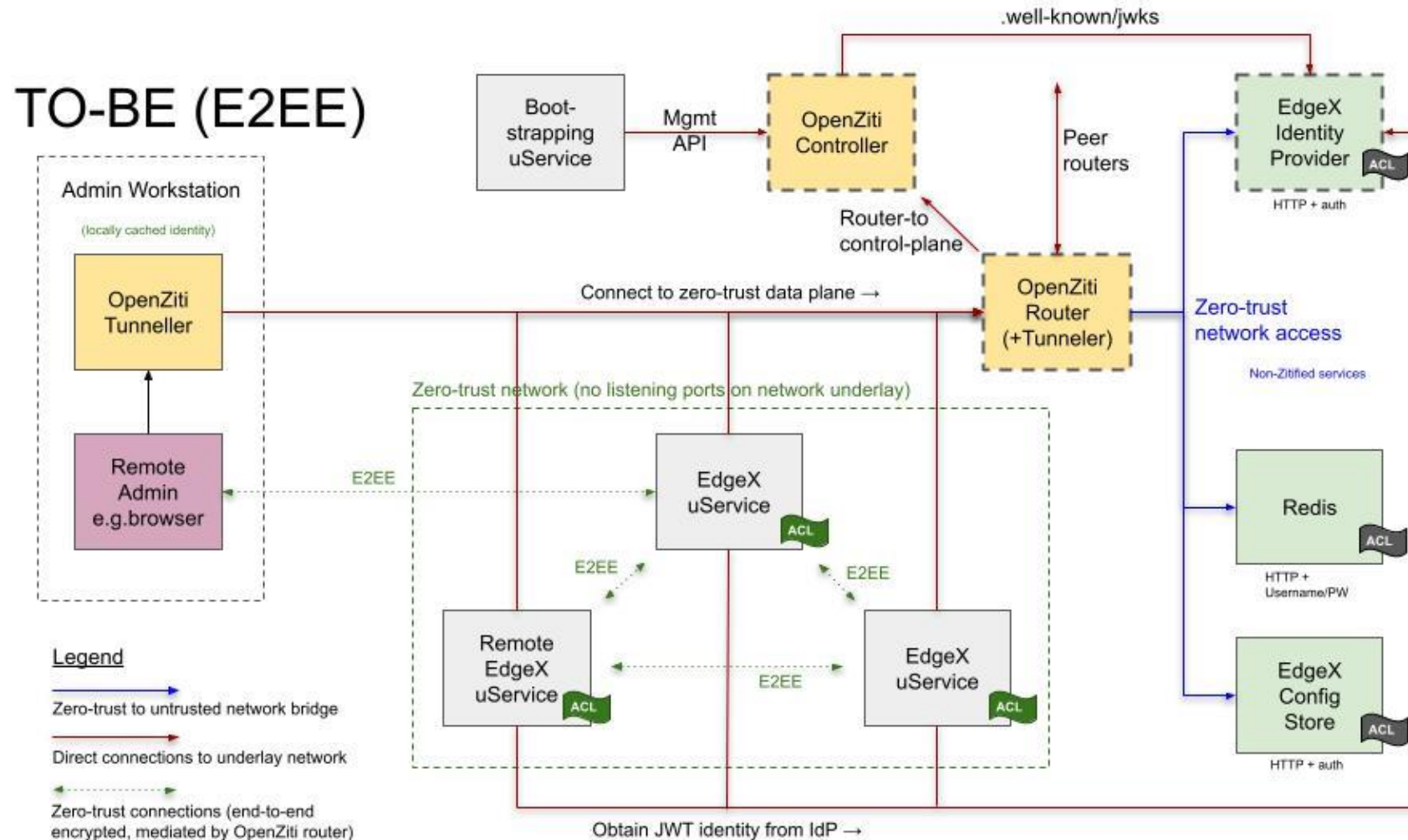



---

## Day 2

---



## Conference Agenda – Day 2

All times in  
PST

- 9:00am - “R” release naming
- 9:10am - Odessa Architecture Discussions cont...
- 10:00am - Odessa Scoping by Working Group
- 12:00pm - Day 2 adjourn



# Naming the next release

- Odessa release (Mengyi & Farshid) - April 2024
- Palau release (Rodney) - Nov 2024
- Queensland release (Bill) - April 2025

A purple starburst shape with multiple points, containing the text "'R' release...".

'R' release...



# Naming the next release

- Odessa release (Mengyi & Farshid) - April 2024
- Palau release (Rodney) - Nov 2024
- Queensland release (Bill) - April 2025
- Rizhao release (Melvin) – Nov 2025



# Day 1 Summary

- Odessa release will be a 3.2 minor release
  - April/May 2024 target release
  - Will not be the next LTS, that will stay at 3.1 which per [LTS policy](#), will be supported period of 2 years (to November 2025)
- Architecture issues discussed so far
  - We analyzed results from recent EdgeX user survey to help direct focus
  - Covered most “In Scope” items from Prewire (see table on next slide)
  - Next, we will address “Under consideration” and “On The Fence” items





# Day 1 Scoping Summary

Theme / Title	In Scope	Priority	T-Shirt	Notes
URI for Files - Parity for C Device Services SDK	✓	High	S	Implementation is clear. Owner: Felix. Assistance and reference impl from Elizabeth (Go)
Common Configuration - Fix corner case bug dealing with removing maps in writable section	TBC	Low	L	The code refactor has a large scope of impact. Seems not to be a critical bug to address. Time better spent on Core-Keeper work to replace Consul?
Replace Hashicorp Consul with EdgeX-Core-Keeper	✓	High	L	Work to update/review/approve core-edgex-keeper (code, docs, tests). Owner: IOTech and Eaton
Replace Hashicorp Vault with Open-Bao	✓	High	S	Liaise with Open-Bao group for delivery timing but expecting to be drop-in replacement with only docker-compose changes needed
Modelling & Relationships – Parent/Child Devices	✓ (STRETCH)	Low	S	Limited to Metadata. Owner: Eaton. Progress via attending Devices WG
Modelling & Relationships – Virtual Device Resources	✓	Med	S	Limited to Device SDKs and Metadata. Owner: Eaton
Modelling & Relationships – Device Metadata in Provision Watchers	✓ (STRETCH)	Low	S/M	Limited to Device SDKs and Metadata. Owner: Eaton
Modelling & Relationships – Protocol Info in Device Definitions	✓ (UCR)	M	S	UCR owner Oracle. ADR & Impl TBC
Modelling & Relationships – Device Functions	✓ (UCR)	M	S	UCR owner Oracle. ADR & Impl TBC
Zero Trust / Secure Distributed EdgeX (OpenZiti Integration)	✓	High	M/L	ADR to approve. Impl largely by Clint



# Continue EdgeX docs redesign

- Big strides made for Napa release. Thanks everybody
- Latest here: <https://docs.edgexfoundry.org/3.1/>
  - Complete Docs Refactoring of individual Device Services – some already done
  - Security section – Better description of individual items, getting started section, service descriptions, how to guides for each (currently each page is a bit of a mixture)
    - Corey to try to test security with current docs and make recommendations for areas for improvement
    - Multiple people could do the actual doc writing updates
    - OpenZiti work will also come in here and require docs in the right place - Clint
  - Refactoring of the APIs section – Lenny
  - Scope. T-Shirt: Medium/Large. Let's try to address through Architect's Meetings





---

# Under Consideration

---



---

# On The Fence

---

# Notification Service Improvements

- Suggested Improvements
  - Currently only email or HTTP; Better to provide support for sending notifications via SMS, web sockets or message protocol (like MQTT or Redis Pub/Sub)- we need community drivers here
  - Request to make using/sending notifications easier. Today, a developer must write code directly into a service to be able to send a notification. Is there a way to do some notifications by configuration? At the very least, better examples need to be provided on how to use the notification service
  - Also needed is a way for the rules engine to trigger notifications.
- T-shirt size: Last year: Small/Medium, self-contained

## Ideas:

- Perhaps build on the back of an “alarm” service – Jim’s requirements work
- eKuiper/rules integration
- Out of Scope for 3.2



# NanoMQ <https://nanomq.io/>

- EMQ (the company behind EdgeX rules engine eKuiper) have built a lightweight message broker called NanoMQ
  - Claimed to be extremely lightweight and very fast (compared to Mosquitto and HiveMQ)
  - Implements Sparkplug, includes an embedded rules engine, brokerless options
  - EMQ pushing to start another LF Edge open-source project
  - Could/should EdgeX consider NanoMQ as an internal messaging option (alongside Redis Pub/Sub and Mosquitto)?
    - LF Edge community and support/maintenance benefits
- EMQ presented at architects meeting in May. Recording here:  
<https://wiki.edgexfoundry.org/display/FA/EdgeX+Architects%27+Meetings>
- Completed crawl phase in EdgeX 3.1
  - I.e. Added changes in compose-builder to swap in NanoMQ (documented as experimental option)
- Jim and Lenny discussed some options with Jaylin and the EMQ team:
  - Inject secrets into NanoMQ so that when the container comes up it is at least minimally secured
    - E.g. equivalent to how Mosquitto knows to use security bootstrapping process and use the /mosquito/config/pwdfilename to secure the broker
  - Provide some comparison (benchmarks) performance data between Mosquitto MQTT and NanoMQ (and potentially Redis Pub/Sub) when running EdgeX
    - Look to provide guidance for users where/how NanoMQ might be better than Mosquitto under certain environments (like resource constrained devices)
- In Scope. Secure mode (stretch). T-shirt: Small. James, Lenny and Cloud to communicate with EMQ



# EdgeX Lite

- Provide capability to build EdgeX services w/o certain capabilities to have a smaller footprint
  - Same as we did with Delay Start capability and ZMQ
  - Mainly focus on Security capabilities that are currently built into all the services that cause their footprint to increase
  - Gives adopters ability to build a lite version when they are not using secure mode
  - Can be done for other capabilities also that we identify as contributing to a larger footprint that some low resource deployments don't need
  - Could do this with the NATS implementation. Out by default, but could be added via build tag. Requires all services (which use MessageBus) that an adopter wants to use to be rebuilt with NATS included
- Previously marked as Stretch goal for Minnesota:
  - Out of Scope - Needs some prioritization, stats based
  - **In Scope: Stripping debug from Go binaries – Lenny.** Also see squashing images (later in deck)
  - Out of Scope: Look at Tiny Go <https://github.com/tinygo-org/tinygo>
  - Consider results from survey of EdgeX adopters on different usage (message bus, security, etc,)







## Caveats / Notes

- Items in the pages following are options at this point
- May be research or design tasks for this release
  - May be partial implementation
- No level of effort has been determined
- No priority has been assigned
- NOTE: scope does not include tasks and work items that come from the main architectural discussions earlier
  - These need to be added and scoped as well



# General

- Upgrade Go version? Napa currently using 1.21 (released Aug)
  - Update expected February, so in scope
- Reduce Docker image footprint associated with “apk update” additions
  - In Scope: squashing via build stages. Ernesto to investigate
- More Metrics added to microservices?
  - Out of Scope
- Helm Charts as release artifacts
  - Continue to maintain and release as we do with edgex-compose
- General EdgeX Project Management enhancements... adjustments to the dev process?
  - Review of the meetings (especially Core and Devices WG)



# Core Working Group

- Core
  - URI for Files (completion work)
  - Common Configuration (completion work)
  - Consul replacement
- User Interface
  - **General discussion about future of UI needed**
    - **Support and maintenance difficulties? – Lenny, Mike, perhaps others to help. Help wanted**
  - Bug: Fields for Provision Watcher Tab don't match the Provision Watcher DTO [#642](#) – in scope
  - Update Angular version – in scope
  - Other new requested features? Still uses MUX – requires refactor
- Test/QA
  - New performance tests? A configurable test harness. [UCR](#)
  - Fuzzing and formalizing fuzzing – On the Fence. James to contact Valina
- Security
  - Other than microservice authentication and Hashicorp changes?
  - eKuiper API security is not enabled when EdgeX is running in secure mode [#4538](#) – see OpenZiti work. **Should raise to eKuiper on App Services WG call**
  - Enable eKuiper to make authenticated EdgeX API calls [#4539](#) – see OpenZiti work
  - edgex-vault logs contain errors about revoking consul token leases [#3544](#) – Tech debt to be looked at
- Icebox – mostly don't warrant architectural discussion
  - Websocket support for support-notifications [#2304](#)
  - [Tech-Debt] Refactor the knowSecrets in compose-builder/makefile to use script or function [#284](#)
  - Support for EdgeX holding services via a fork in the edgexfoundry-holding organization [#233](#) – **to close**
  - Add support for services to notify systemd socket when ready [#1301](#) – **to close**
  - Support automatic migration of Devices between Device Services [#1451](#)
  - Module exploration - remove or replace [github.com/kr/logfmt](https://github.com/kr/logfmt) [#2616](#)
  - Various noted fuzzing errors



# Device Services

- Previously mentioned Device Relationships etc
- New CAN Device Service (C Device Service)
  - Likely 3.1.0 and 3.2 etc
- New Siemens S7 Device Service (Go-Lang Device Service)
  - Repo in holding – review in progress
  - Likely 3.1.0 and 3.2 etc
- Allow AutoDiscovery to generate Device Profile  
<https://github.com/edgexfoundry/edgex-go/issues/4422>
- Icebox – all seem to need user pull and/or resources
  - Handle both JSON request bodies as well as CBOR request bodies #488
  - DS operatingState doesn't go down post DS stop (C) #356
  - Implement size constraints for devices and profiles #18
  - Support regular expressions in assertions #839
    - Real-world UCR needed
  - DS Filtering implementation (ADR already in place)
  - Downsampling - Throttling device data



# Application Services

- Enhance documentation
  - E.g. how to guides
- Bug: [App service out of memory when the function process is slower than receiving events #1516](#)
- Different northbound endpoints?
  - Sparkplug - IOtech may be able to help
- Icebox
  - Add pipeline function to send notification via Support Notifications
  - Use nano message IPC for ASC pluggable pipeline function
  - Cloud export examples
  - [LLRP] Add LLRP Inventory specific service metrics
  - Additional App Service metrics



# DevOps

- [#438](#) Implement git-cliff, a git-chglog replacement - done
- [#376](#) Automate release branch creation - done
- Support for EdgeX holding services via a fork in the edgexfoundry-holding organization [#233](#) – done
- Separate go version for build and go version for compatibility [#4430](#)
- Cleanup miscellaneous issues. Ernesto to discuss with Lenny and Bill
- Squashing Docker images
- Meta data on Docker images – Darryl to discuss with Ernesto





---

# Day 3

---

## Conference Agenda – Day 3

All times in  
PST

- 9:00am - Business and Marketing Topics
  - Odessa Scoping Summary Table
- 10:00am - Project Process Improvements
- 10:30am - Lessons Learnt, Evaluation, etc
- 11:00am - Day 3 adjourn







---

# Business Topics

---

# Business Topic Agenda

- EdgeX Website and Social Media (Laura Álvarez, IOTech)
  - SEO, keyword research and web-traffic analysis - current stats and status
  - Social Media approach and latest stats
- EdgeX Developer Evangelism (James)
  - Technical use cases and other collateral
  - Developer assistance – videos, tutorials etc
  - Developer events and trade shows etc
  - Other ideas?

## Future of the Outreach WG?

- Wider topic – how best to accomplish Outreach work?



# EdgeX Website Update

SEO status at Lesvki Release (late 2022):

- IOTech responsible for
  - [Release updates](#)
  - [Tech Talks updates](#)
  - Reporting of site stats including docs site
    - In Google [data studio](#)
- Technical SEO Audit undertaken throughout 2023
  - Assigned to Laura Álvarez (IOTech)
  - Original recommendations shown (a lot of TODOs)

INDEX	ITEM CHECKED	ACTION	RESPONSIBILITY	STATUS
2	Code Validation	An <a href="#">HTML validation check</a> on the homepage shows 90 Errors and 14 warnings. We should review the errors and fix them if possible.	Capitan	TO DO
3	Accessibility	A check on the homepage scores 54/100 on <a href="https://www.webaccessibility.com/">https://www.webaccessibility.com/</a> . We should review and implement any improvements if possible.	Capitan	TO DO
4	Clean Index	Some pages are empty and need to be removed. Some pages are low-quality pages and need more content to be added.	Members	TO DO
5	Title Tags & Meta Descriptions	The Titles and Meta Descriptions are not <u>optimized</u> . Some of them are missing and others need review.	IOTech	DONE
7	Image Alt Text	All images on the website are missing the Alt Text. This needs to be added to include keywords and relevant descriptions.	IOTech	TO DO
8	Site Structure	Some floating pages are not <u>organized</u> and the best practice is to group them into relevant categories.	IOTech	DONE
9	Heading Tags	48% of pages are missing an H1, and others need to be <u>optimized</u> .	IOTech	DONE
13	Noindex Tags	Some pages have a <u>noindex</u> tag. These pages should be reviewed to check if the tag should be removed.	IOTech	DONE
14	XML Sitemap	The XML sitemap is present on the website. However, the wrong sitemap is submitted to GSC and needs to be updated.	IOTech	DONE
18	Mobile & Desktop Core Web Vitals	As the Google Search Console property was recently created, a couple of weeks of data will be needed to check this.	Waiting for results	TO DO
19	Mobile & Desktop Page Speed	The mobile website has a ranking of 47/100 and the desktop website 68/100. We should try to implement the recommendations set out by Google if possible.	IOTech	TO DO



# EdgeX Website Update

- Everything actioned
  - Code Validation
  - Accessibility
  - Clean Index
  - Image Alt Text
  - Mobile & Desktop Vitals
  - Mobile & Desktop Speed
- Except members section which needs updated text provided by each company

## SEO status at Napa Release:

### SUMMARY

INDEX	ITEM CHECKED	ACTION	RESPONSIBILITY	STATUS
2	Code Validation	An <a href="#">HTML validation check</a> on the homepage shows 90 Errors and 14 warnings. We should review the errors and fix them if possible.	Capitan	DONE
3	Accessibility	A check on the homepage scores 54/100 on <a href="https://www.webaccessibility.com/">https://www.webaccessibility.com/</a> . We should review and implement any improvements if possible.	Capitan	NOT NEEDED
4	Clean Index	Some pages are empty and need to be removed. Some pages are low-quality pages and need more content to be added.	Members	TO DO
5	Title Tags & Meta Descriptions	The Titles and Meta Descriptions are not optimized. Some of them are missing and others need review.	IOTech	DONE
7	Image Alt Text	All images on the website are missing the Alt Text. This needs to be added to include keywords and relevant descriptions.	IOTech	DONE
8	Site Structure	Some floating pages are not organized and the best practice is to group them into relevant categories.	IOTech	DONE
9	Heading Tags	48% of pages are missing an H1, and others need to be optimized.	IOTech	DONE
13	Noindex Tags	Some pages have a noindex tag. These pages should be reviewed to check if the tag should be removed.	IOTech	DONE
14	XML Sitemap	The XML sitemap is present on the website. However, the wrong sitemap is submitted to GSC and needs to be updated.	IOTech	DONE
18	Mobile & Desktop Core Web Vitals	The Google Search Console property reported good results and no actions are needed.	IOTech	DONE
19	Mobile & Desktop Page Speed	The mobile website has a ranking of 47/100 and the desktop website 68/100. We should try to implement the recommendations set out by Google if possible.	IOTech	DONE



# EdgeX Website Update – Keyword Research

## Brief Summary:

- 'first ranking' column is where we started, before making the changes
- 'current ranking' column shows this month's results
- 'changes since last month's' column shows the difference from last month
- This is creating some changes in traffic and users, as Search Engines are showing more EdgeX page than it did before
- New keywords ranking now
- [https://docs.google.com/spreadsheets/d/1lYqcTwwEXzgVa9ftO8-dcQE0DD\\_jvVTPo2UkDdsxqIU/edit#gid=0](https://docs.google.com/spreadsheets/d/1lYqcTwwEXzgVa9ftO8-dcQE0DD_jvVTPo2UkDdsxqIU/edit#gid=0)

Theme	Keywords	Searches / Month	EdgeX Foundry		
			First Ranking	Current Ranking	Changes since last month
LF Edge	linux foundation	27000	-	-	-
	linux foundation edge	50	14	8	1
	lf edge companies	<10	-	7	0
	lf edge projects	<10	22	32	-7
	lf edgex	<10	-	2	0
EdgeX Foundry	edgex	1300	1	1	0
	edgex foundry	720	1	1	0
	edge x	480	1	1	0
	edge x foundry	70	1	1	0
	edgex ecosystem	<10	-	1	0
	edgex levski	<10	-	1	0
	edgex foundry levski	<10	-	1	0
	edgex platform	<10	-	1	0
	edgex foundry members	<10	-	1	0
	Edge IoT	edge iot	2900	85	70
iot edge computing		1300	-	-	-
edge iot platform		40	-	3	5
edge iot middleware platform		<10	-	6	-4
edge computing		74000	-	-	-
Edge Software / Computing	edge solutions	2900	-	-	-
	edge computing technology	1600	-	-	-
	edge software	1300	-	24	-2
	edge cloud computing	1000	-	-	-
	edge computing solutions	880	-	-	-
	edge computing platform	390	-	59	7
	edge computing systems	140	-	-	-
	edge software solutions	50	-	36	-1
	edge software platform	10	10	10	1
	Open Source / Software	open source software	49500	-	-
open source platform		1300	-	-	-
open source software platform		90	72	25	44
open source edge computing platform		20	-	1	0
open source edge platform		<10	1	1	0
open source edge software		<10	-	1	0
Open Edge	open edge software	50	-	20	1
	open edge platform	<10	8	13	-3
	open edge data platform	<10	-	4	-5
	open edge data solutions	<10	-	43	33
IoT Software	iot development	1900	-	-	-
	free iot platform	480	-	88	11
	iot software platform	210	-	-	-
	open iot platform	90	93	30	36
	iot software solutions	70	-	-	-
	iot open software	<10	-	23	48
IoT Edge	iot edge platform	90	12	6	3
	iot edge solutions	70	46	14	30
	edge iot platform	40	-	3	5
	iot edge software	<10	-	7	7



# EdgeX Website Update – Traffic Analysis

- SEO changes and content additions seems to be leading to positive results:
  - Comparing data from Jan-Feb vs Oct-Nov 2023 (before and after changes on the keywords)
  - Overall traffic has improved, but specifically organic traffic is getting better results than it was before, and it is the first source of traffic, followed by direct
  - Despite the organic growth, there has been a decrease in direct traffic and referral, which could be improve if members include links to EdgeX in their pages

Session default channel group ▾ +	↓ Users	Sessions	Engaged sessions
◇ SHOW ALL ROWS			
	4,275 vs. 3,933 ↑ 8.7%	7,099 vs. 6,752 ↑ 5.14%	3,493 vs. 3,354 ↑ 4.14%
<b>Organic Search</b>			
1 Oct - 30 Nov 2023	2,822	4,779	2,437
1 Jan - 28 Feb 2023	2,143	4,001	2,248
% change	31.68%	19.45%	8.41%
<b>Direct</b>			
1 Oct - 30 Nov 2023	1,036	1,490	614
1 Jan - 28 Feb 2023	1,262	1,718	586
% change	-17.91%	-13.27%	4.78%
<b>Referral</b>			
1 Oct - 30 Nov 2023	463	737	417
1 Jan - 28 Feb 2023	581	921	539
% change	-20.31%	-19.98%	-22.63%



# EdgeX Social Media

- EdgeX now running its own Social Media
  - Posting 1-2 times a week - run by IOTech
  - If you have a post you'd like to make, let James/Gavin/Laura know
- Stats (Oct-Nov vs Aug-Sep)
  - LinkedIn
    - Improvement in Engagement rate 7.31% (+136%)
    - Good Click through rate still at 3.4% (no change)
    - Increase in Impressions: 3,948 vs 1,966 previous period (+100%)
  - Twitter
    - Steady CTR at 3% (same as last period)
    - 500 impressions (100% increase)
- Posting Guidance
  - LinkedIn > Twitter for volume, impressions, traffic quality
  - Content Dos
    - Release announcements
    - Highlight feature or value
    - Real use case/demonstration/reference
    - Offer or announce something of value/something new
    - Quick poll can provide good impression #s (not as high click through)
  - Content Don'ts
    - (Repetitive) Event announcements
    - Repeat content
    - Non-EdgeX product
    - Adopter replays (of the week)
    - Highlight the obvious (docs location, video location)
    - Tell me something I already know or repeat something over and over, tell me something outside of the project I don't care about



# EdgeX Developer Evangelism

- Encourage EdgeX references regarding adoption/usage
  - **More written notes?** Eaton's use case document was very well received
  - **More adopter series?** Elizabeth Lee to present potential adopter series in future (Edge CV/AI related)?
- More Tech Talks? How-To videos?
  - **Which areas do we think could be most valuable?** Security, Simple Cook Book,
  - **Be aware of needs to keep things up to date, do we have the resources, what is the ROI, hard to keep relevant**
  - **Probably better to focus on the docs and helping people get up and running**
  - **Look at usage stats for the videos**
- More Hackathon Events?
  - **Intel's EdgeX Coding Competition was successful (in China) but less so in US and Europe**
    - James has a blog story coming about that
- More in-person events or trade shows?
  - **LF OS Summit in Seattle (Apr 24) and/or Vienna (Sep 24)? Others**
- Future of the Outreach WG?
  - **Wider topic – how best to accomplish Outreach work? Seems difficult to maintain without active volunteers, bring under control of TSC as a bi-weekly item on the meetings**







---

# Scoping Summary (Day 2 additions)

---



# Day 1 and 2 Scoping Summary

Theme / Title	In Scope	Priority	T-Shirt	Notes
URI for Files - Parity for C Device Services SDK	✓	High	S	Implementation is clear. Owner: Felix. Assistance and reference impl from Elizabeth (Go)
<del>Common Configuration – Fix corner case bug dealing with removing maps in writable section</del>	TBC	Low	L	The code refactor has a large scope of impact. Seems not to be a critical bug to address. Time better spent on Core-Keeper work to replace Consul?
Replace Hashicorp Consul with EdgeX-Core-Keeper	✓	High	L	Work to update/review/approve core-edgex-keeper (code, docs, tests). Owner: IOTech and Eaton
Replace Hashicorp Vault with Open-Bao	✓	High	S	Liaise with Open-Bao group for delivery timing but expecting to be drop-in replacement with only docker-compose changes needed
Modelling & Relationships – Parent/Child Devices	✓ (STRETCH)	Low	S	Limited to Metadata. Owner: Eaton. Progress via attending Devices WG
Modelling & Relationships – Virtual Device Resources	✓	Med	S	Limited to Device SDKs and Metadata. Owner: Eaton
Modelling & Relationships – Device Metadata in Provision Watchers	✓ (STRETCH)	Low	S/M	Limited to Device SDKs and Metadata. Owner: Eaton
Modelling & Relationships – Protocol Info in Device Definitions	✓ (UCR)	M	S	UCR owner Oracle. ADR & Impl TBC
Modelling & Relationships – Device Functions	✓ (UCR)	M	S	UCR owner Oracle. ADR & Impl TBC
Zero Trust / Secure Distributed EdgeX (OpenZiti Integration)	✓	High	M/L	ADR to approve. Impl largely by Clint
Continue EdgeX Documentation redesign	✓	High	M/L	Device Services, Security and API section
NanoMQ – Add security to our NanoMQ option	✓ (STRETCH)	Low	S	Continue communication with EMQ team





# Process Improvements - Agenda

- EdgeX Meetings – Days and Times check
- UCR and ADR process
- Issue and PR process
- Community Chat: GitHub Discussions
- Third-Party Libraries
- EdgeX Project Boards
- Example Repo Tagging – Napa decision: change tagging process to have examples work against specific releases – like the rest of the repos and dev cycle



# EdgeX Meeting Times

- Mondays
  - Device Services @ 4pm PT (alternate weeks)
  - Outreach/Marketing @ 9am PT (3<sup>rd</sup> Monday each month)
- Tuesdays
  - DevOps @ 9am PT (2<sup>nd</sup> Tuesday each month)
  - Application Services WG @ 3:30pm AZ Time (alternate weeks)
  - Core @ 4pm PT
- Wednesdays
  - TSC / Architect's Meetings @ 8am PDT (alternate weeks)
- Thursdays
  - No meetings
- Friday
  - China Project Meeting 12:00am (1<sup>st</sup> Friday each month)

- Suggestion to combine Core and Device Services WG meetings into same meeting time
- Similar people on both, but maintain separate groups, responsibilities, boards, etc
- Suggestion to drop the Monday Devices meeting
- Stop the Outreach call
- Possible long-term option to have a single technical meeting
- Keep TSC meeting every 2 weeks. Architect's Meeting on calendar is useful



# ADR / UCR Process

- During Levski cycle we added Use Case Record (UCRs) to the process
  - <https://docs.edgexfoundry.org/3.0/design/Process/>
  - Aim was to better agree needs and requirements before diving into Architectural Design Records (ADRs)
  - Believe this is working well for us? Any suggested tweaks?
  - Process is agreed to work well



# Issue and PR Process

- Any issues with Issues to report?
- Are we under-defining the Issue/Case creation template?
- Last time we added some minor changes:
  - Added “WIP” in commit message when fixing a bug introduced in current cycle
  - To ensure review standards are followed, added committers checklist in the pull request template
  - Are these working for us? Any other changes needed?



# Community Chat: GitHub Discussions

- <https://github.com/orgs/edgexfoundry/discussions>
- Daily questions posted with much discussion – thanks to all contributors!!
- Suggestions for refining the process / management of discussions:
  - Mark discussions as closed when resolved
  - Mark specific comments as “answers” – Stack Overflow style
  - Keep conversations specific to original question. Open new discussions when needed
  - Promote “Show and Tell” section for EdgeX adopters / use cases
  - James to review the open questions
- How to ensure questions raised result in awareness of requirements/needs?
  - Just ask the person raising the question to create an issue (if needed) and reference the discussion
- Other thoughts/comments?





## EdgeX Project Boards - <https://github.com/orgs/edgexfoundry/projects>

- Time for all to transition to Odessa boards – By End of December?
  - Remove the Dones
  - Clean out In progress, QA Review, etc.
  - Move appropriate Icebox items back to the Backlog (leave issues not going to be addressed in the Icebox)
- Start a new Odessa Documentation update (or rename Napa?)
- Feedback on the different project boards that are being used?
  - Most working groups use “new” GitHub boards
  - Time to migrate all remaining boards from “classic” to “new”
  - Some old boards to delete/close – e.g. Certification WG, Kamakura Docs, etc
    - Lenny closing these now! James to check any others later



# Manual Release Testing

- <https://wiki.edgexfoundry.org/display/FA/Manual+Testing>
- Have any important/new manual tests emerged?
- Plan to add a checklist for future manual release testing
- James to review list and verify with TAF team which are covered





---

## Lessons Learnt, Continuous Evaluation, etc

---

# Lessons Learned in Napa (What we said last time)

To review and add new thoughts:

- Positives

- Managed workload well to hit the release targets
- Release process gets better each time
- Doc refactoring in Napa went well

- Areas for improvement

- Continue to improve on commit messages
- Continue to improve documentation
- More community coding members needed
- Awareness of different support options for a wide range of requirements people have
- Refine the meeting times to include more participants



# Planning Meeting Lessons Learned

- Release Planning Meeting
  - Any lessons learned?
  - Any thing that could be done better?
  - Start doing, continue doing, stop doing?
  - What worked well and what did not?
  - More efficient and use less time for each cycle
  - Prewire continues to be useful to focus discussions here
  - Flexible on time, awareness of attendees – APAC participation important
    - So switch to a US/APAC time basis for the calls



# Thank You

EDGE X FOUNDRY™  
A Linux Foundation project under 

